



TJERNLUND PRODUCTS, INC.

1601 Ninth Street • White Bear Lake, MN 55110-6794
 PHONE (800) 255-4208 • (651) 426-2993 • FAX (651) 426-9547
 Visit our web site • www.tjernlund.com



MODEL MPC MODULATING PRESSURE CONTROL INSTALLATION INSTRUCTIONS

 Recognize this symbol as an indication of important Safety Information!

OWNER INSTRUCTIONS, DO NOT DESTROY

WARNING

THESE INSTRUCTIONS ARE INTENDED AS AN AID TO QUALIFIED, LICENSED SERVICE PERSONNEL FOR PROPER INSTALLATION, ADJUSTMENT AND OPERATION OF THIS PRODUCT. READ THESE INSTRUCTIONS THOROUGHLY BEFORE ATTEMPTING INSTALLATION OR OPERATION. FAILURE TO FOLLOW THESE INSTRUCTIONS MAY RESULT IN IMPROPER INSTALLATION, ADJUSTMENT, SERVICE OR MAINTENANCE POSSIBLY RESULTING IN FIRE, ELECTRICAL SHOCK, CARBON MONOXIDE POISONING, EXPLOSION, PERSONAL INJURY OR PROPERTY DAMAGE.

**DO NOT DESTROY. PLEASE READ CAREFULLY AND
 KEEP IN A SAFE PLACE FOR FUTURE REFERENCE.**

TABLE OF CONTENTS

	Page (s)
MPC Modulating Pressure Control Description	1
Installation Restrictions.....	1
Cautions	1
Sample and Reference Pressure Connections	2
Pressure Sensing Tube Locations & Installation.....	2-4
Wiring	5-6
Supply Make-up / Combustion Air Pressure Set Point.....	7
MPC Sequence of Operation and Operation Confirmation	7
Balancing Connections to Multi-Story Exhaust Chases/Shafts	8
Changing MPC Pressure Control Program Defaults	8-9
Warranty and Replacement Parts	10

Tjernlund Products welcomes your comments and questions. Address all correspondence to:
Customer Service • Tjernlund Products, Inc. • 1601 Ninth Street • White Bear Lake, MN 55110-6794
Call us toll free at 800-255-4208, visit our web site @ www.tjernlund.com or email us at fanmail@tjfans.com.

DESCRIPTION

The MPC (without integral UC1 interlock) Controller is designed to modulate exhaust or supply air so that the programmed pressure set point is maintained. Two MPC Controllers will be needed if controlling both exhaust and supply air. The MPC I Controller (with integral UC1 burner interlock) must be used if appliance interlock is required.

FOR EXHAUST APPLICATIONS

Pressure is measured in a chase, duct or vent at the farthest point from the Exhaust Fan. As exhaust volume increases within the duct/chase/vent the resulting reduction in measured pressure causes the controller to speed the fan up to handle the additional exhaust volume and slow the fan down when the exhaust volume is reduced to maintain a consistent exhaust pressure.

FOR SUPPLY / MAKE-UP AIR APPLICATIONS:

Pressure is measured within a mechanical room space or duct connected to the outdoor air supply fan. As air is exhausted from the monitored space, the MPC Controller modulates the supply air fan speed to maintain the pressure set point air pressure within the space or duct.

GENERAL INFORMATION

Each MPC Controller is electrically factory line tested before shipment. After opening carton, inspect thoroughly for hidden damage. If any damage is found notify freight carrier and your distributor immediately and file a concealed damage claim.

INSTALLATION RESTRICTIONS

1. **Do not** use the MPC Controller with gas or oil fired heating equipment. Instead use the model MPC I Controller (with integral UC1 burner interlock) and the required number of MAC-Series Multiple Appliance Controls. Follow instructions and wiring diagrams included and perform "Operation Confirmation" check on Page 7 to validate the interface is operating correctly.
2. The MPC controller is intended for indoor installation only. Do not mount on a heat source or in an environment that exceeds 122°F (50°C) or 85% relative humidity.
3. The maximum wire distance from the Control to a VFD or ECM Exhaust Fan Motor is 300 feet. Install the MPC as close to the pressure sampling point as possible to avoid delayed response to pressure changes. **Do not** exceed a sampling tube length of 15 feet. The default fan acceleration rate may need to be increased for sampling tube lengths greater than 10 feet.

CAUTIONS

The MPC Controller must be installed by a qualified installer (an individual properly licensed and/or trained) in accordance with all local codes or, in their absence, in accordance with the National Electrical Code and Uniform Mechanical Code if applicable. Failure to install, maintain and/or operate the MPC Controller in accordance with manufacturer's instructions may result in conditions which can produce bodily injury and property damage.

1. Disrupt external supply power to MPC Controller when making wiring connections and servicing. Failure to do so may result in personal injury and/or equipment damage.
2. All installation restrictions and instructions specific to the exhaust or supply Fan installation instructions must be followed.
3. Make certain the power source is adequate for the MPC requirements. Do not add equipment to a circuit when the total electrical load is unknown.

SAMPLE AND REFERENCE PRESSURE CONNECTIONS

<u>Application</u>	<u>Sensing Tube Sample Location</u>	<u>MPC Pressure Port</u>	<u>Reference Pressure Location</u>	<u>MPC Pressure Port</u>
Exhaust	Bottom of Chase	Connect to Negative (-)	Room at Bottom of Chase	Positive (Port Open)
Open Supply	Mechanical Room	Positive (Port Open)	Adjacent Room	Connect to Negative (-)
Sealed Supply	End of Supply Duct	Connect to Positive (+)	Heater Mechanical Room	Negative (Port Open)

Recommendations based on MPC Control being installed in the same room as the sample location. If the MPC is installed in an adjacent space, pneumatic connections must be made to the open Pressure Ports that are indicated above.

PRESSURE SENSING TUBE INSTALLATION LOCATIONS

FOR EXHAUST CHASE APPLICATIONS

Install MPC and Pressure Sensing Tube at the bottom of a chase/shaft serving multiple floors of bathroom, kitchen or clothes dryer exhaust. The Pressure Sensing Tube must be installed below the farthest exhaust connection from the termination in a section of the chase/shaft that sees no air movement so that only static pressure is measured. Sample above any lint cleanout at bottom of shaft.

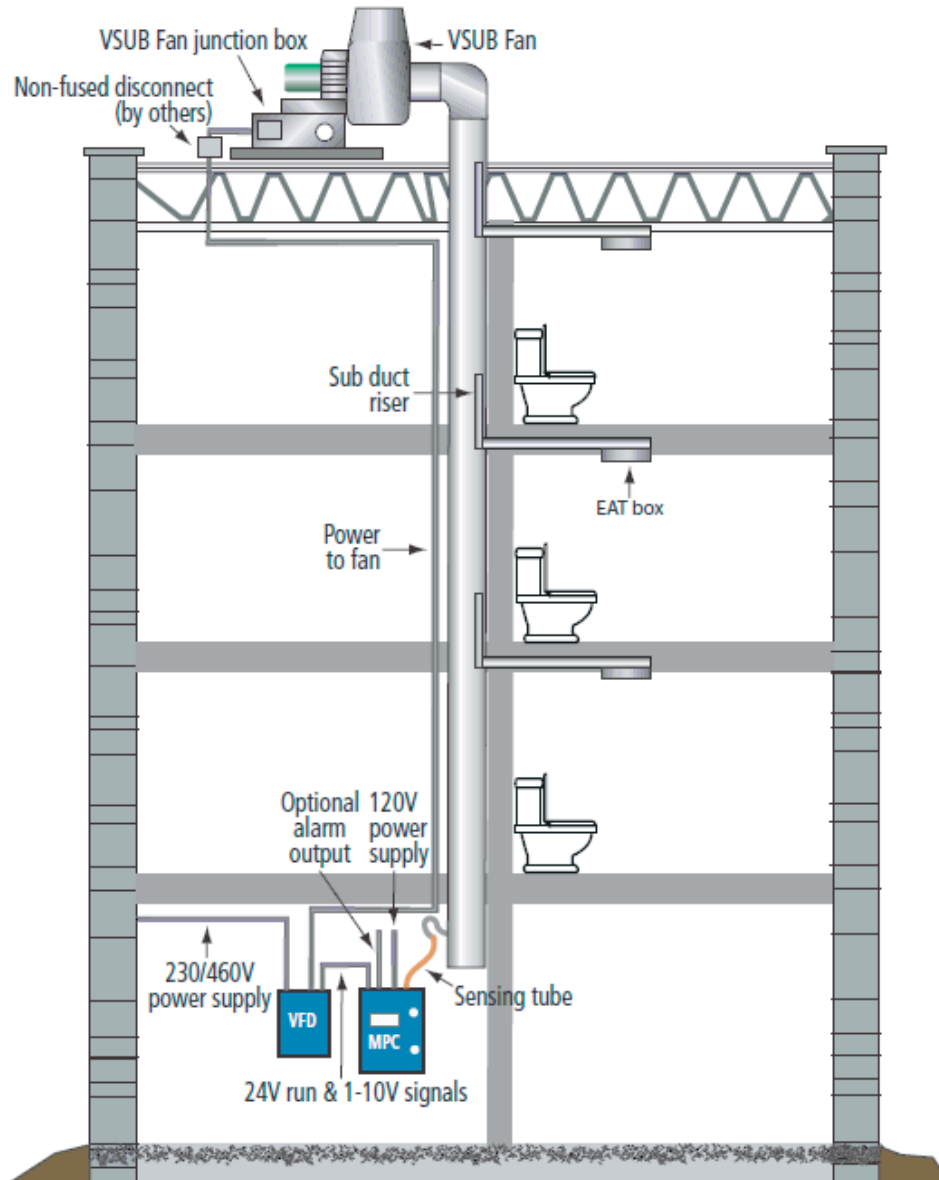

MULTIPLE DRYERS JOINED IN A COMMON HORIZONTAL DUCT

The sensing tube should be installed in the vent cap of a tee or at the rear of a common exhaust manifold, in back of the vent connector that is farthest from the Dryer Exhaust Fan. The tee is necessary so that only static pressure is measured, (See Figure A). If the pressure sensing tube is installed in the side of a duct it will also measure velocity pressure, giving an incorrect signal back to the Pressure Control. If mounting on the side of the duct is unavoidable, the sensing tube should be flush to the interior wall of the duct. Avoid sampling near or in elbows. Duct connections should be sealed to prevent leakage or entrainment. Installer must provide access for lint clean out.

FIGURE A

IF POSSIBLE, THE SENSING TUBE SHOULD BE LOCATED ONE MAINFOLD PIPE DIAMETER BEHIND THE DRYER FURTHEST FROM INDUCER

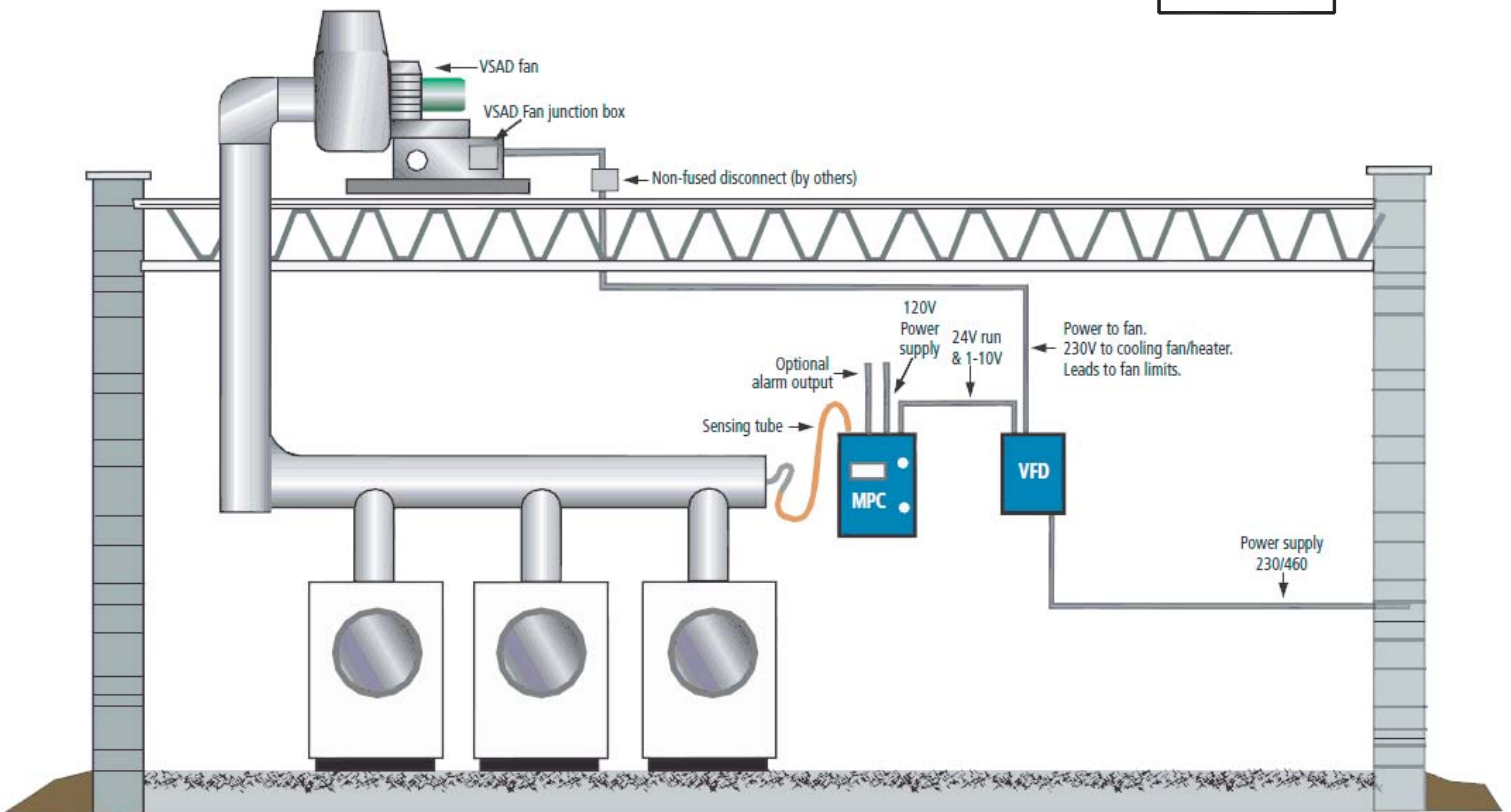
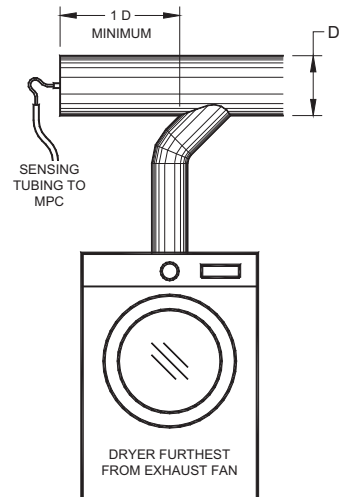

FOR "OPEN" MAKE-UP AIR APPLICATIONS

In "Open" mode the mechanical room air is sampled and an adjacent space is referenced. Referencing an adjacent space within the building typically provides a more stable reference pressure than referencing outdoor air. Varying wind speeds will affect outdoor reference pressure and are difficult to neutralize. The goal is to reference static pressure. Don't sample pressures at locations that can be affected by frequently opened doors, elevator shafts, ventilation fans and diffusers. The optional model IPS-1 adjacent space Reference Pressure Sensor includes a decorative cover, sampling tube and fittings may be used in conjunction with the MPC Pressure Control. It reduces the effects of air movement on the sampling tube and provides a finished look.

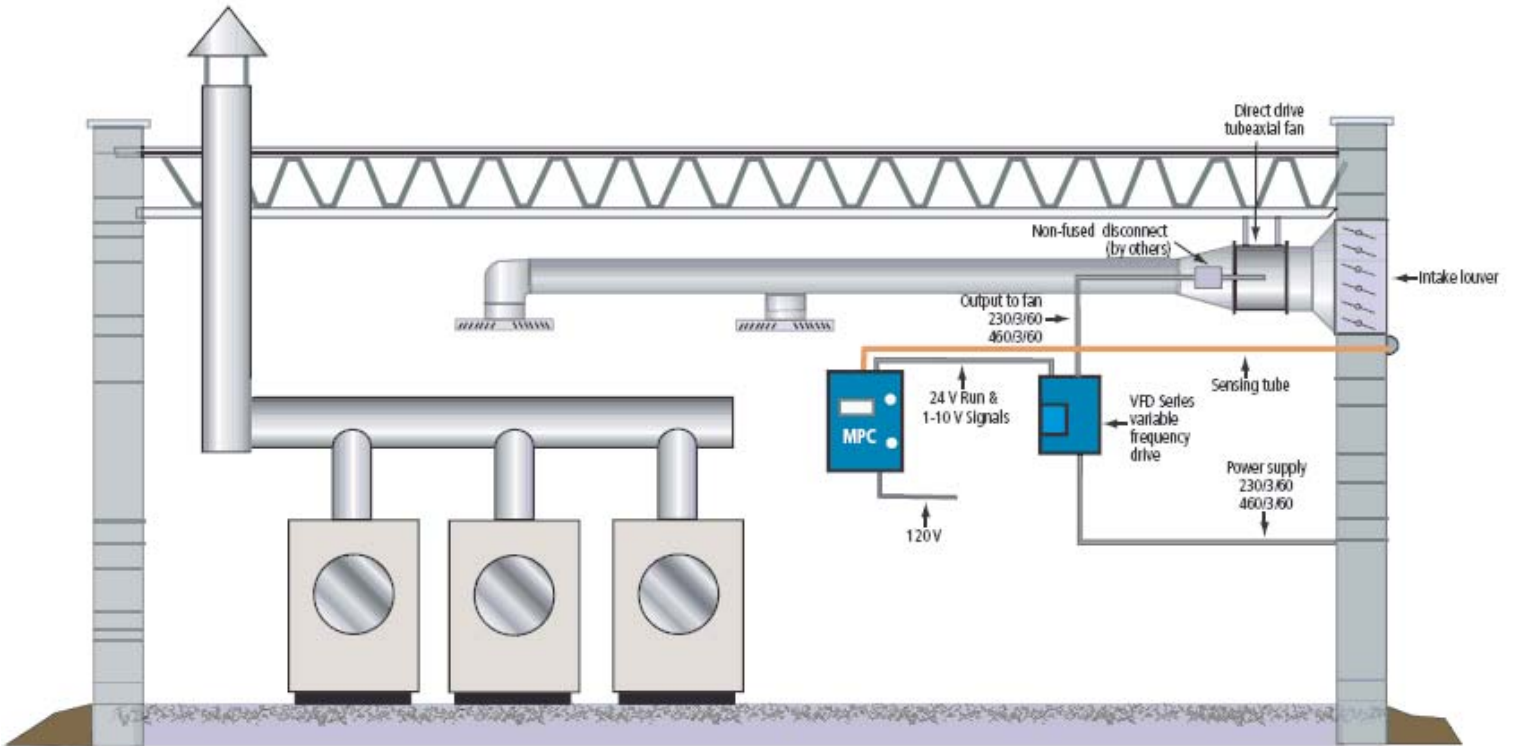

PESSURE SENSING TUBE INSTALLATION

1. Follow sensing tube installation location recommendations. Use a sharp drill bit to reduce burr, drill a 1/4" hole for pressure sensing tube. Screw sensing tube bracket to duct/chase with sampling hole centered, (See Figure B).
2. Insert stainless steel sensing tube through 1/4" hole enough to just penetrate interior of duct/chase and lock in place with compression ferrule and nut, (See Figure B).
3. Connect sampling tube with included tubing to the correct pressure port on the exterior of the MPC enclosure. The Pressure Ports are located on the Top Right side of the MPC Cabinet. These are the pneumatic connection points to the Pressure Control inside the MPC. The Rear Port (-) is for those applications where a negative pressure is required. This port is typically used for Exhaust applications. The Front Port (+) is typically for those supply air applications where a neutral or positive pressure is required. See "Sample and Reference Connections", Page 2 for port information. For rear Negative (-) and front Positive (+) port location on MPC, (See Figure C). **Important:** Excessive additional lengths of tubing will delay the response of the Fan which can lead to control lag.

FIGURE B

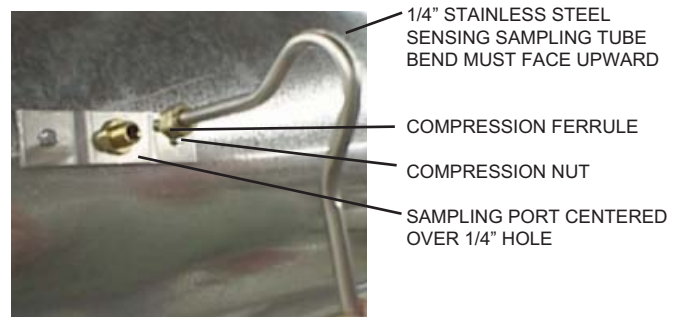
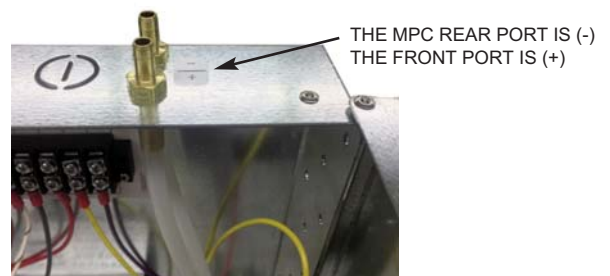

FIGURE C



The MPC must be wired by a qualified installer (an individual properly licensed and/or trained) in accordance with these instructions and in accordance with all local codes or in their absence, with the current editions of NFPA 70, National Electrical Code in the U.S. or CSA C22.1-12 Canadian Electrical Code in Canada.

All 120 V wiring from the MPC to the Fan junction box must be appropriate Class 1 wiring as follows: installed in rigid metal conduit, intermediate metal conduit, rigid non-metallic conduit, electrical metallic tubing, Type MI Cable, Type MC Cable, or be otherwise suitably protected from physical damage.

The maximum distance the 1-10 VDC output from the MPC to the VFD or ECM motor is 300 feet. Exceeding this distance can result in lower than desired signal strength. 1-10 VDC wiring should be in metal conduit or utilize shielded cable. Non-shielded signal wiring can be influenced by outside conditions resulting in undesirable operation of the MPC control.

IMPORTANT:

Installer must supply overload and disconnect protection as dictated by local and national codes. Do not use a fused disconnect. MPC Control supply power may be switched through a building management system, pressure switch or other 120 VAC switch.

IMPORTANT:

MOTOR ROTATION MUST BE VERIFIED PRIOR TO OPERATION CHECKS.

If using the model MPC in conjunction with a VFD, fan rotation must be checked to validate that the motor is turning in the correct direction. Fans should have rotation stickers on the housing or motor mount. Activate the MPC as directed on page 7 and then disrupt operation so that motor rotation can be detected as the motor coasts down. If rotation is incorrect, change by switching any two of the 3 power output leads from the VFD to the fan motor. Verify proper rotation by repeating steps above.

MPC WIRING

Modulating Pressure Control



TJERNLUND

Draft • Combustion Air • Ventilation
800.255.4208 www.tjernlund.com

Electrical Specifications

Power supply: 120 VAC, 7 amps minimum

Switch: 120 VAC, 7 amps minimum

Run: 120 VAC, 5 amps out maximum

Alarm: 10 amps at 120 VAC

Control: 20 VA maximum out



Intertek

LEGEND

	= 5 VDC
	= 24 VAC
	= 115 VAC

Maximum ambient temperature for this control is 122° F (50° C).
Field conductors are to be copper (Cu) only and to be rated 140° F (60° C) or higher.
Torque all terminal block screws to 10 lb-in.

EC Motor OR VFD

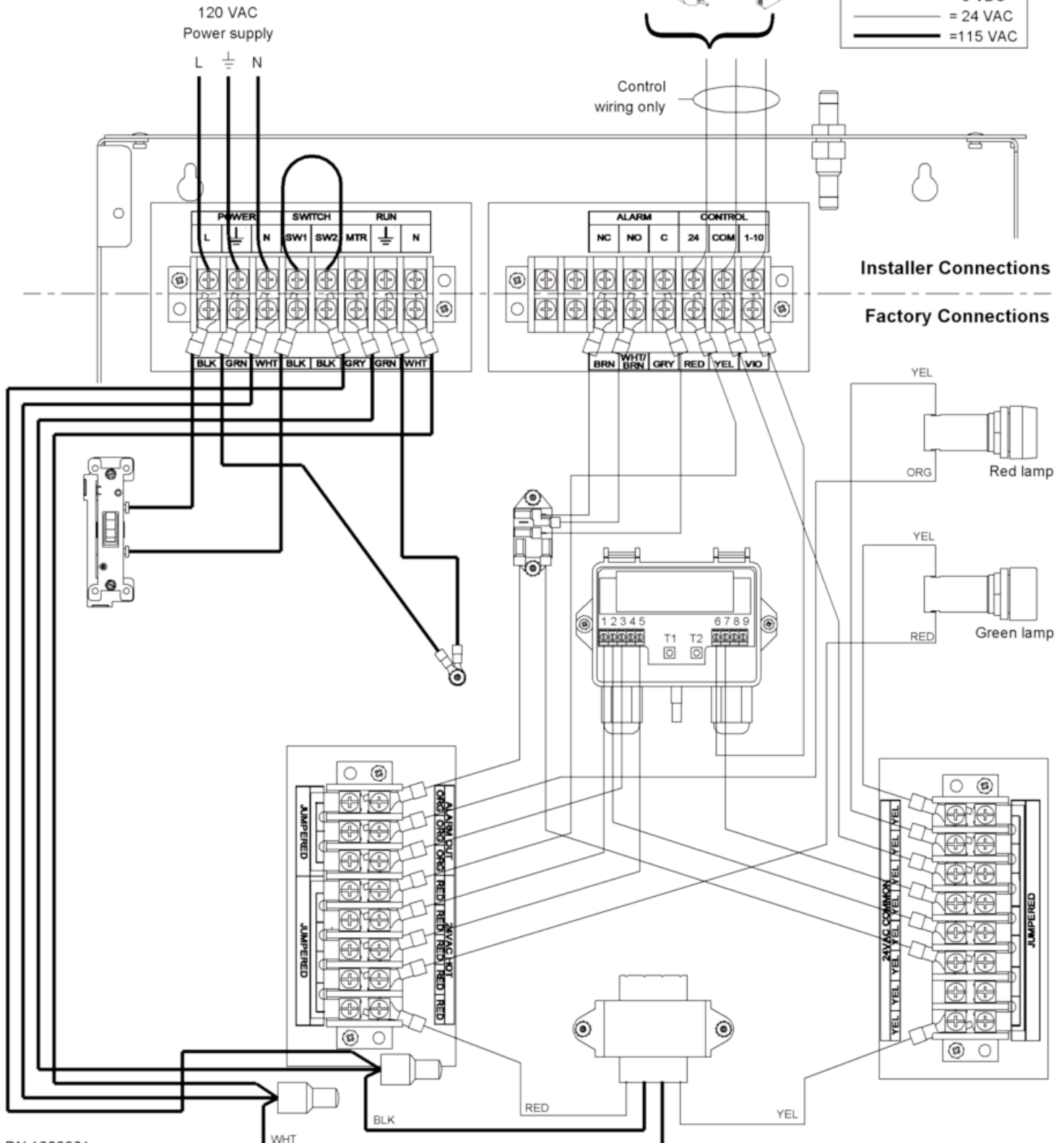
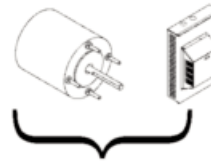

SUPPLY MAKE-UP / COMBUSTION AIR PRESSURE SET POINT

MPC Controllers are defaulted to a 0.10" w.c. set point. To enable the SET POINT 2, default setting (0.00" w.c.) for Supply Make-up / Combustion air, a jumper wire must be installed between terminals 8 & 9 on the right hand side of the Pressure Control terminal strip, (See Figure D). Remove Pressure Control cover with small phillips screwdriver to access terminal strip.

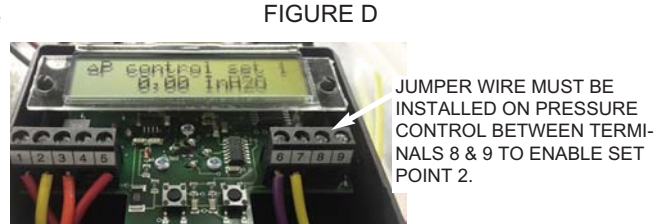

MPC SEQUENCE OF OPERATION

1. With any external 120 VAC supply power switch to MPC activated and the MPC internal power switch ON, 120 VAC is supplied to:
2. The MTR terminal of the Power Terminal Block (can be used to power 120 VAC intake damper motors up to 5 amps or energize the coil of a line voltage coil VFD activation relay).
3. Simultaneously it energizes the 24 VAC transformer to supply power to:

The 24 VAC hot of the external Green run light on the MPC cover.

Terminal 5 of the Pressure Control to power the common of its N/O alarm relay contacts.

The 24 terminal of the Pressure Control Terminal Block. (Used to energize Tjernlund Products VFDxxx-MPC Series VFD activation relay within VFD electrical enclosure)

Terminal 1 of the Pressure Control, activating it to measure system pressure and to output a proportional 1-10 VDC signal to the 1-10 terminal of the Control Terminal Strip. The 1-10 VDC signal from the Control Terminal Strip is wired directly to an ECM motor input or to a VFD input to vary the fan speed to maintain the set point as volume, stack effect, wind loading and reference pressure change.

If the Pressure Control max's out the output (10 VDC) for greater than 10 seconds (field adjustable), the Pressure Control Alarm Circuit will activate, powering the MPC external Red fault light with audible alarm as well as any external alarm or BMS that are wired to the alarm circuit while continuing to try to make the set point. The alarm will remain until the set point is reached or power is removed from the MPC Controller.

PRESSURE FAULT SEQUENCE

If the Pressure Control max's out the output (10 VDC) for greater than 10 seconds (field adjustable), the Pressure Control Alarm Circuit will activate, powering the MPC external Red fault light with audible alarm as well as any external alarm or BMS that are wired to the alarm circuit while continuing to try to make the set point. The alarm will remain until the set point is reached or power is removed from the MPC Controller.

MPC OPERATIONAL CONFIRMATION

Establish 120 VAC supply power to the MPC and switch MPC internal power switch to the ON position.

The Pressure Control should become energized and output a 1-10 VDC signal to the VFD or ECM fan motor. Verify that a 0.10" w.c. for exhaust or 0.00" w.c. for supply air set point is obtained by the Pressure Control.

Remove the tubing from the stainless steel Sampling Tube to disrupt the pneumatic connection to the MPC.

The Pressure Control will continue to output an increasingly higher 1-10 VDC signal to make the set point.

When the output reaches 10 VDC a 10 second delay will occur and then the Pressure Control Alarm Circuit will activate, powering the MPC external Red fault light with audible alarm as well as any external alarm or BMS that are wired to the alarm circuit.

Reconnect the tubing to the Sampling Tube.

The safety circuit will reset when the pressure set point is once again achieved.

BALANCING CONNECTIONS TO MULTI-STORY EXHAUST CHASES/SHAFTS

IMPORTANT: Do Not use Balancing Dampers or Automatic Flow Balancers for clothes dryer applications.

In general, the further away from a Fan a connection is, the harder it is to make pressure. To balance the pressure for all levels of a chase/shaft we recommend that kitchen and bath duct connections have adjustable dampers or automatic flow balancers installed prior to the connection to the exhaust chase/shaft.

Automatic flow balancers require no action. If adjustable dampers are installed close all dampers and starting at the lowest level open dampers until desired flow is achieved. Repeat on all remaining levels.

CHANGING MPC PROGRAM DEFAULTS

THE FACTORY PRESET PROGRAM SETTINGS ARE AS FOLLOWS:

PROGRAM OPTION	FACTORY PRESETS	ADJUSTMENT RANGE
Pressure Units of Measure	Units InH ₂ O	Units PA
Operating Mode	Control Mode	Do Not Change
Parameter	Diff. Pressure	Do Not Change
Setpoint 1 (Use for Draft)	0.10	0 to 40 (PA 0 to 100)*
Setpoint 2 (Use for Supply/Comb Air)	0	0 to 40 (PA 0 to 100)*
* NOTE: A negative value can not be set on the Pressure Control, however, the Pressure Control can display a negative pressure reading. Pressure Control will read either negative or positive pressures depending on what sensing port is used and type of application. See "Sample and Reference Pressure Connections", Page 2.		
Output Voltage	V=10.0 V	Do Not Change
P-Parameter	50	1-999 (Acceleration Rate)
I-Parameter	3.15	Do Not Change
Controlling Mode	Positive/Heating	Do Not Change
Alarm Delay Time	10s	1 Second to 15 Minutes

The Pressure Control must be powered to enter the program mode. For the model MPC activate any external switch and turn the internal power switch on. Push the left button (T1) for 2 seconds, make any necessary program changes and cycle through the remaining programs by pushing the T2 button until the display reads MENU. In menu mode the 1-10 VDC output is disrupted until you exit.

To enable the SET POINT 2 for supply/combustion air a jumper wire must be installed between the last two terminals 8 & 9 on the right hand side of the Pressure Control. See "Supply Make-Up / Combustion Air Pressure Set Point", Page 7.

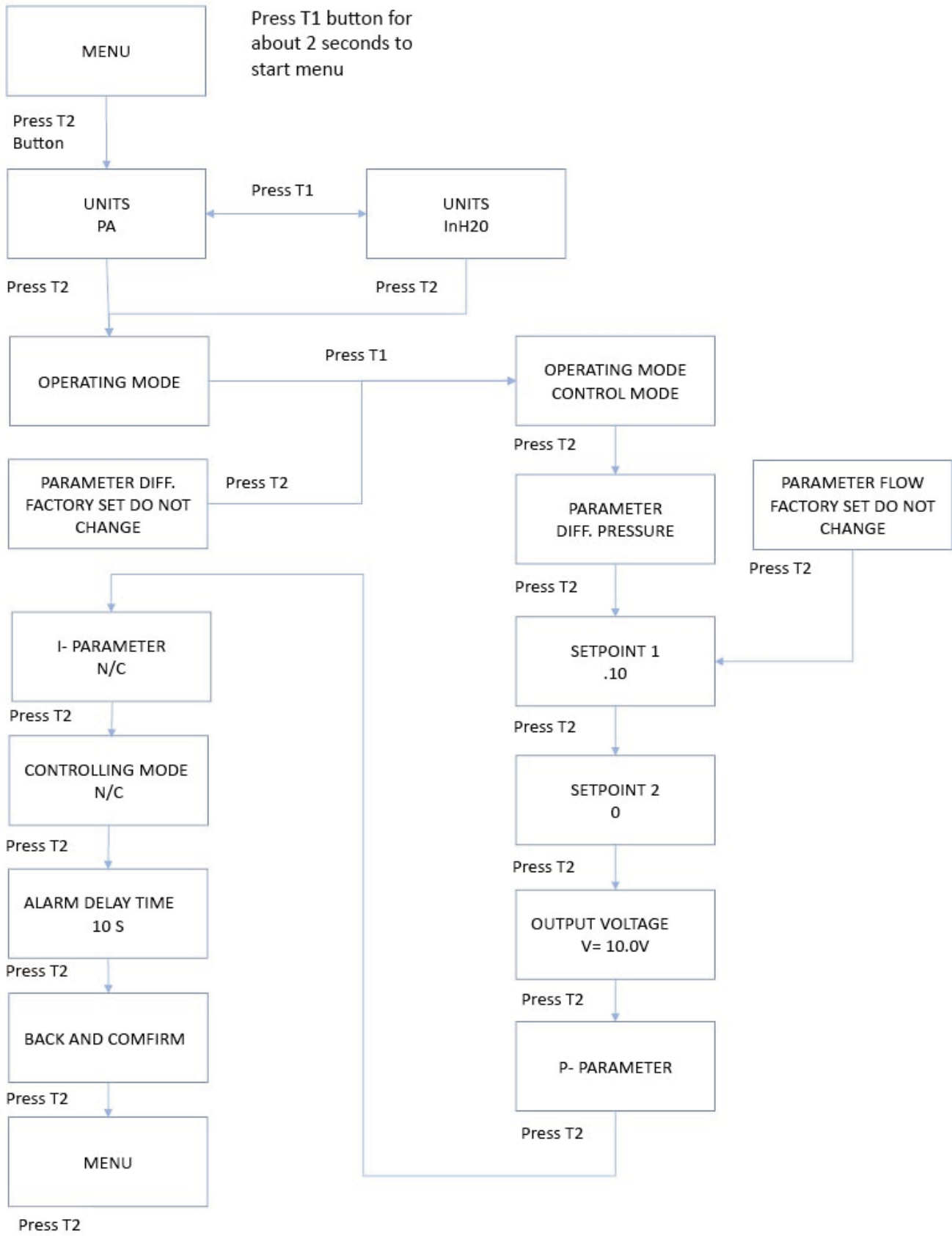

TROUBLESHOOTING

If it is necessary to measure voltage during troubleshooting. Extreme caution must be exercised to prevent injury. If you are unable to determine the defective part with the use of this guide, call your Tjernlund distributor or Tjernlund Products direct at 1-800-255-4208 for further assistance.

1. If you have any questions about a MPC Controller or if it requires adjustment or repair, contact your installer, contractor or service agency.
2. If you require technical information contact Tjernlund Products, Inc. at 1-800-255-4208 with the following information.
 - Model of the Exhaust/Supply Air Fan that MPC is controlling as shown on the Fan nameplate.
 - Name and telephone number of installer and any service agency who performed work on the system.
 - Date of original installation and dates any service work was performed.
 - Details of the problem as you can best describe them.

LIMITED PARTS WARRANTY AND CLAIM PROCEDURE

Tjernlund Products, Inc. warrants the components of the MPC for one year from date of installation. This warranty covers defects in material and workmanship. This warranty does not cover normal maintenance, transportation or installation charges for replacement parts or any other service calls or repairs. This warranty DOES NOT cover the complete MPC if it is operative, except for the defective part.

Tjernlund Products, Inc. will issue credit or provide a free part to replace one that becomes defective during the one year warranty period. Proof of date of the installation in the form of the contractor sales/installation receipt is necessary to prove the unit has been in service for under one year. All receipts should include the date code of the MPC to ensure that the defective component corresponds with the complete unit. This will help prevent possible credit refusal.

After the faulty component is determined, return it to your Tjernlund distributor for replacement. Please include MPC date code component was taken from. The date code is located inside the Electrical Box enclosure. The first two digits are the day, second two digits the month and third two digits are the year of manufacture. The last two digits are the Tjernlund manufacturing order number. If the date code is older than one year, you will need to provide a copy of the original installation receipt to your distributor. Credit or replacement will only be issued to a Tjernlund distributor after the part has been returned prepaid to Tjernlund and verified defective.

WHAT IS NOT COVERED

- Product installed contrary to our installation instructions, altered, neglected or misused
- Product that has been wired incorrectly
- Any freight charges related to the return of the defective part
- Any labor charges related to evaluating and replacing the defective part

REPLACEMENT PARTS

<u>Component</u>	<u>Part Number</u>
Pressure Control	950-9355
Alarm & Safety Circuit Relays	950-1040
Indoor Pressure Sensor (Optional)	IPS-1

TJERNLUND LIMITED ONE YEAR WARRANTY

Tjernlund Products, Inc. warrants to the original purchaser of this product that the product will be free from defects due to faulty material or workmanship for a period of (1) year from the date of original purchase or delivery to the original purchaser, whichever is earlier. Remedies under this warranty are limited to repairing or replacing, at our option, any product which shall, within the above stated warranty period, be returned to Tjernlund Products, Inc. at the address listed below, postage prepaid. THERE ARE NO WARRANTIES WHICH EXTEND BEYOND THE DESCRIPTION ON THE FACE HEREOF, AND TJERNLUND PRODUCTS, INC. EXPRESSLY DISCLAIMS LIABILITY FOR INCIDENTAL OR CONSEQUENTIAL DAMAGES ARISING FROM THE USE OF THIS PRODUCT. THIS WARRANTY IS IN LIEU OF ALL OTHER EXPRESS WARRANTIES AND NO AGENT IS AUTHORIZED TO ASSUME FOR US ANY LIABILITY ADDITIONAL TO THOSE SET FORTH IN THIS LIMITED WARRANTY. IMPLIED WARRANTIES ARE LIMITED TO THE STATED DURATION OF THIS LIMITED WARRANTY. Some states do not allow limitation on how long an implied warranty lasts, so that limitation may not apply to you. In addition, some states do not allow the exclusion or limitation of incidental or consequential damages, so that above limitation or exclusion may not apply to you. This warranty gives you specific legal rights and you may also have other rights which may vary from State to State. Send all inquiries regarding warranty work to Tjernlund Products, Inc. 1601 9th Street, White Bear Lake, MN 55110-6794. Phone (651) 426-2993 • (800) 255-4208 • Fax (651) 426-9547 • Email fanmail@tjfans.com.