



Submittal Data Sheet

VSRI14 ROUND INLINE FAN

Job Name: _____

Equipment Rep: _____

Contractor: _____

Prepared By: _____

Arch./Engr.: _____

Date: _____

Description:

VSRI-Series Variable Speed Round Inline Fans are suitable for providing combustion air or ventilation.

Use with the CPC-3 Constant Pressure Controller, closed-loop VFD, and TD-Series Pressure Transducer for an automatic-variable speed system which will modulate to always deliver the perfect amount of combustion air or ventilation. For an adjustable-fixed speed system, use an open-loop VFD to manually adjust the speed of the VSRI.

Housing Construction:

Continuously welded, heavy-gauge, corrosion resistant, enamel coated steel housing.

Impeller Construction:

Non-overloading, aluminum impeller that is statically and dynamically balanced.

Motor:

Three phase, 1/2 HP, 208-230/460 VAC, TEFC, E-PLUS 3, Inverter Duty Rated.

Standard Equipment:

- 4" x 4" weatherproof junction box
- PSA-1 Fan Proving Switch
- FFP-1 Fire and Freeze Protection Limit

Optional Equipment:

- CPC-3 Constant Pressure Controller
- IPS-1 Indoor Pressure Sensor Decorative Cover Fitting
- TD-Series Pressure Transducer
- VFD-Series Variable Frequency Drive

Listings:

UL 705 - Power Venters

Temperature Rating:

120° F / 49° C

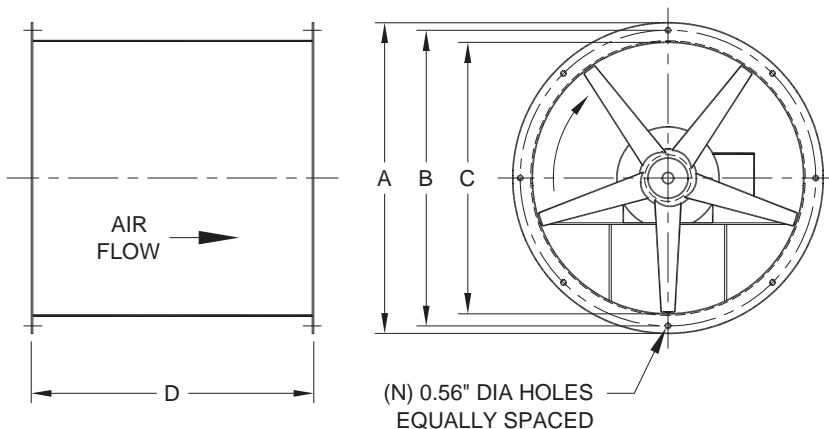

VSRI14	
Fan Type	Tubeaxial
Voltage	3x230 / 3x460
Amps	2.1 / 0.95
RPM	1750
Power Rating	1/2 HP
Weight	33 Lbs
Dimension A	16.88"
Dimension B	15.88"
Dimension C	14.25"
Dimension D	19"
Mounting Holes (N)	(8) 0.56"