



Submittal Data Sheet EC650US Utility Set Fan

Job Name: _____

Equipment Rep: _____

Contractor: _____

Prepared By: _____

Arch./Engr.: _____

Date: _____

Description:

Utility Sets are designed for continuous operation to exhaust Lint-laden air, foul air, fumes, odors. Utility sets are also an excellent choice for general exhaust and supply requirements of commercial and light industrial applications. ECUS Series feature energy saving EC motors, which are ideal for applications requiring demand control ventilation, for example, apartment buildings, multi-story dryer venting, multi-purpose rooms with differing rates of ventilation, hi-rise buildings - single fan on riser exhausting multiple spaces. If constant (reduced) speed operation is desired, the fan's speed can be manually adjusted and set via the integral potentiometer located in the electrical enclosure. The potentiometer permits the system balancer to dial in the necessary air flow rate. Motor protection is integrated in the electronics of the motor.

Use with the MPC-Series Modulating Pressure Controller for an Automatic-Variable Speed system which will modulate to always deliver the correct amount of exhaust or supply air.

Housing Construction:

The housing is rotatable and made from heavy gauge galvanized steel.

Impeller:

Aluminum wheel statically and dynamically balanced.

Motor:

ECM 120/1/60 VAC, 1/4 HP, 1750 RPM

Max Temperature:

300° F / 150° C

Weight:

66 Lbs

Listings:

UL 705, UL 762



Sound:

Octave Bands	1	2	3	4	5	6	7	8	LwA
Level at Inlet	65	72	69	71	72	65	59	49	75

Warranty:

1 year mechanical

Standard Equipment:

Motor mounted speed control, Weather cover, Access door, Drain w/ plug - 1/2"

Optional Controls & Equipment:

- MPC Modulating Pressure Controller
- MPC1 Modulating Pressure Controller Interlocked
- MAC1E Multiple Appliance Control (Use with MPC1)
- MAC4E Multiple Appliance Control (Use with MPC1)
- IPS-1 Indoor Pressure Sensor Decorative Cover
- FFP-1 Freeze and Fire Protection Limit (FFP-1 For combustion air applications only!)

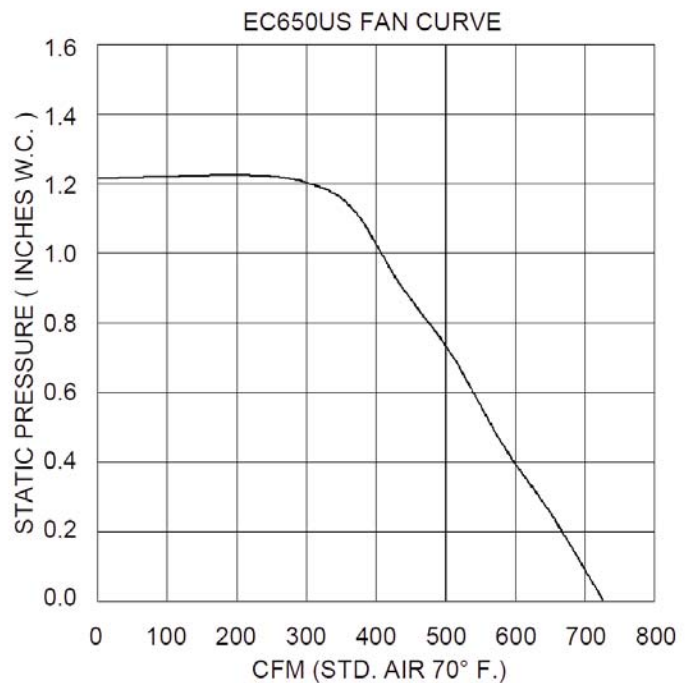

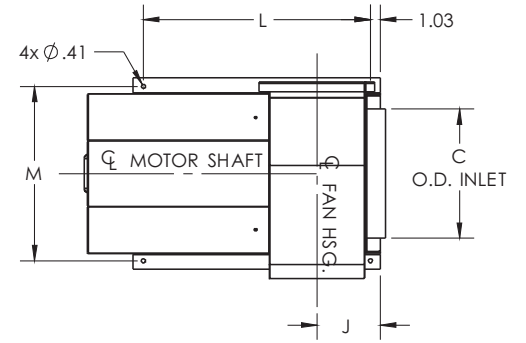
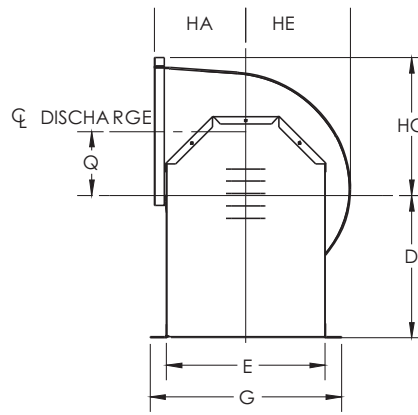
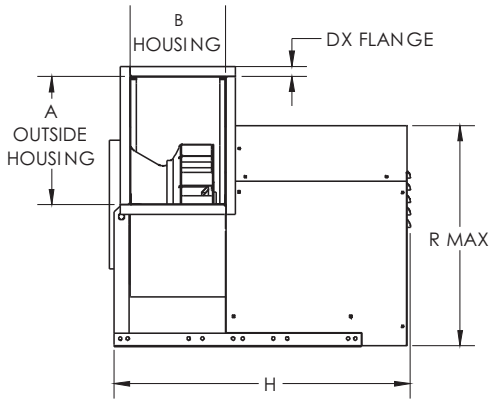

FOUNDATION PLAN

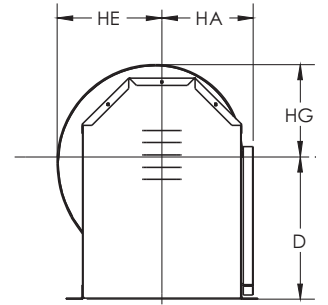
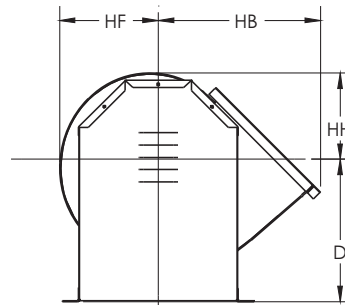
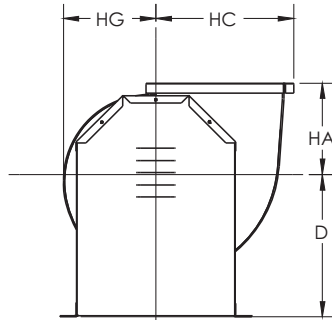
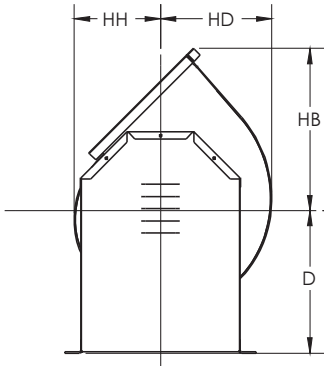

FIELD ADJUSTABLE

MODEL	A	B	C	D	DX	E	G	H	HA	HB	HC	HD	HE	HF	HG	HH	J	L	M	Q	R
EC650US	11.24	8.59	11.13	14.50	1.00	16.18	19.50	28.55	9.06	15.07	12.24	9.74	9.17	8.64	8.10	7.57	5.95	21.50	17.75	5.61	22.43

DIMENSIONS IN INCHES